

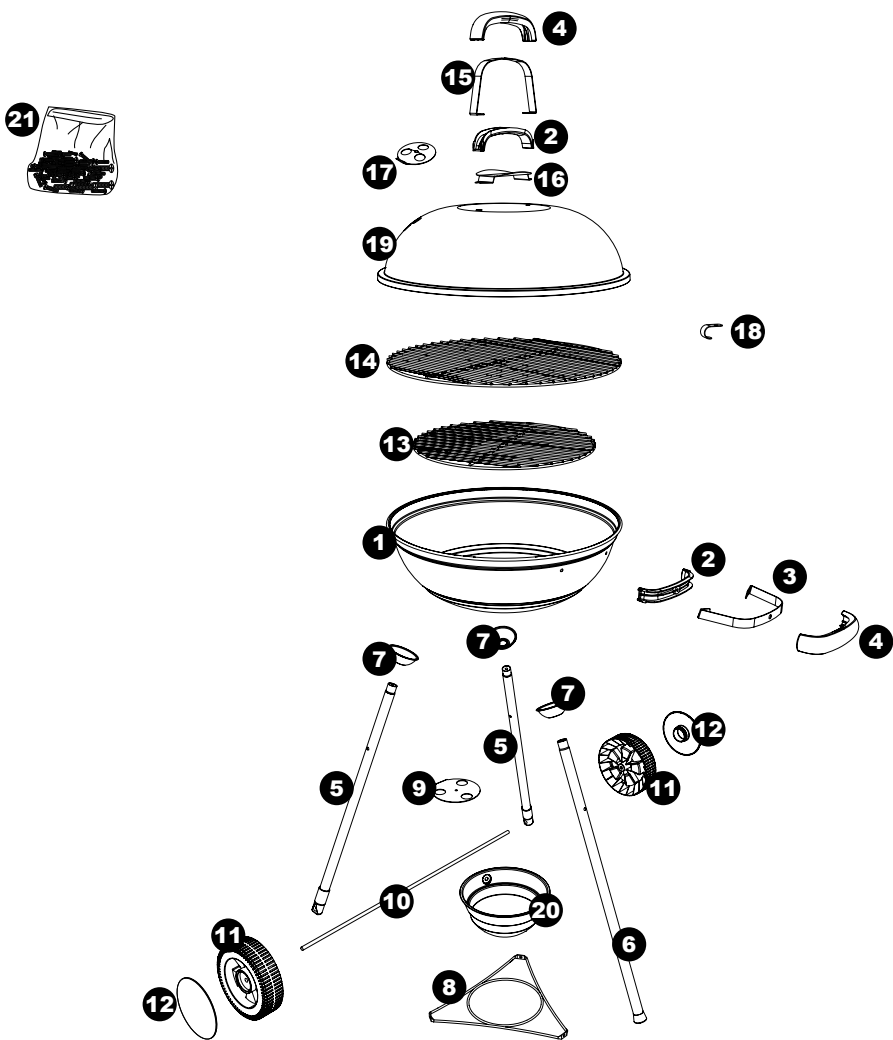













TOM 340430i EN











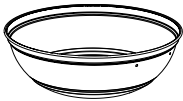

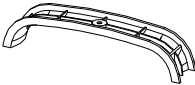

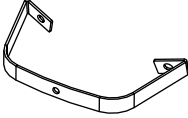



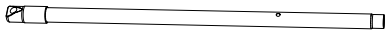



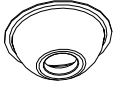

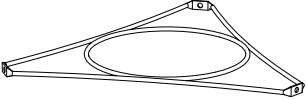
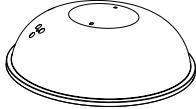
	6 x 20	3
	6 x 16	2
	4 x 30	3
	4 x 12	4
	3,5 x 9,5	2
	Ø25	3

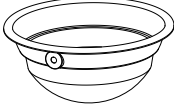
	fibre	Ø6	2
		Ø6	2
		Ø4	7
	fibre	Ø4	1
		Ø4	5
	break nut/ frein	Ø4	2

	Ø6	2
	Ø8	2

1		x 1	12		x 2
2		x 2	13		x 1
3		x 1	14		x 1
4		x 2	15		x 1
5		x 2	16		x 1
6		x 1	17		x 1
7		x 3	18		x 1
8		x 1	19		x 1
9		x 1	20		x 1
10		x 1	21		x 1
11		x 2			

1

3,5 x 9,5 Ø4x12 Ø4 Ø4

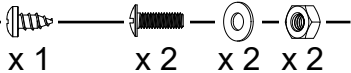
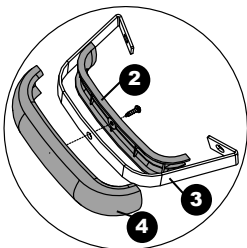
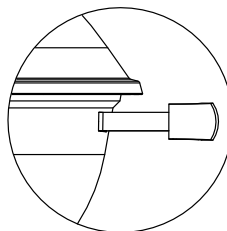
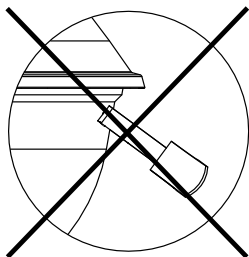
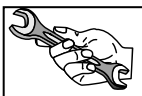
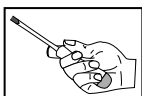
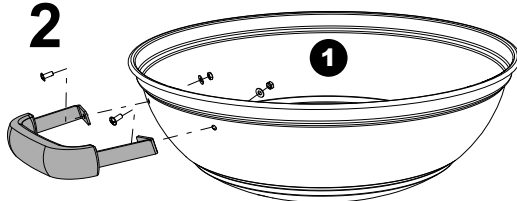
**1****2****2**

Ø6 x 20

Ø25

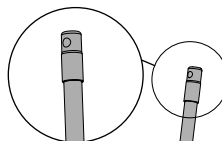
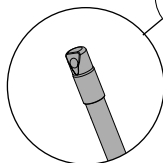
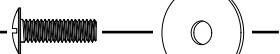
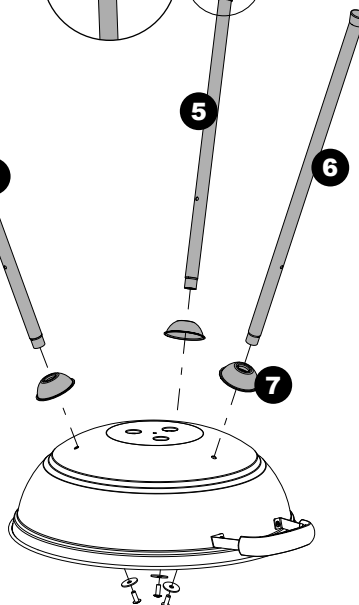
**5****5****6****7**

3

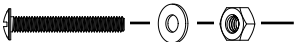
$\varnothing 4 \times 30$ $\varnothing 4$ $\varnothing 4$

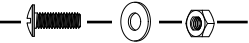
 x 3 x 3 x 3

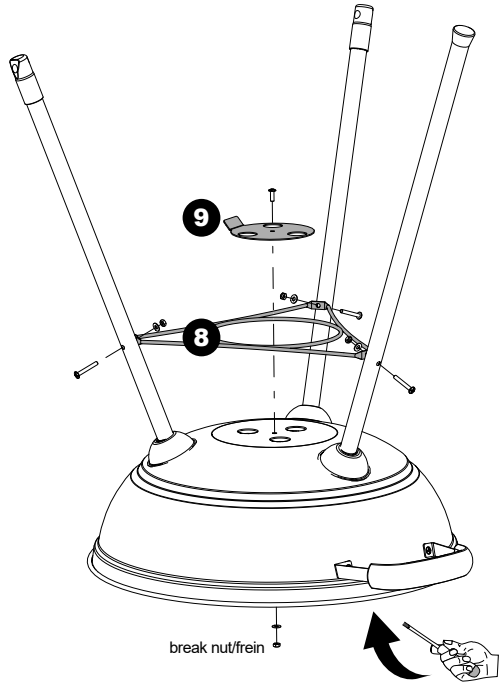
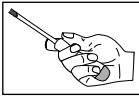
$\varnothing 4 \times 12$ $\varnothing 4$ $\varnothing 4$

 x 1 x 1 x 1 break nut / frein

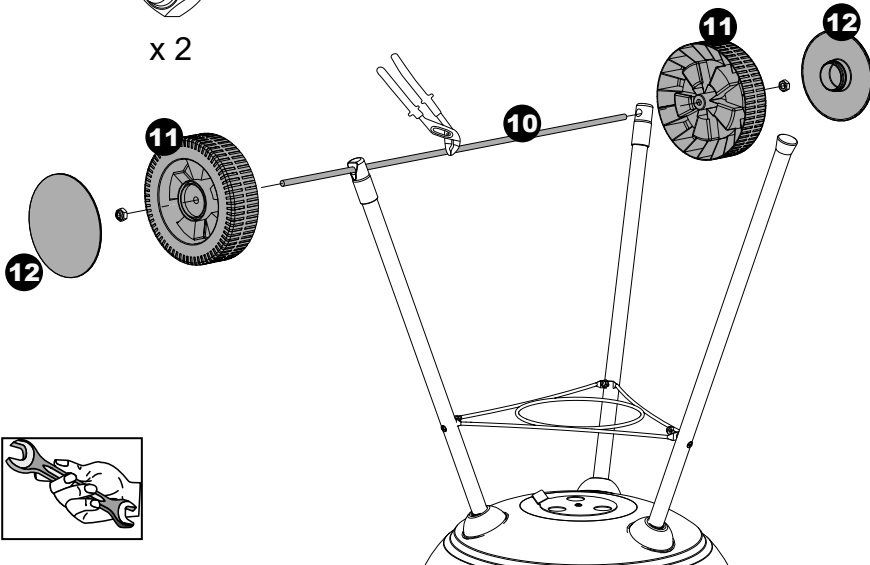
**4** $\varnothing 8$ Nylstop

 x 2



5



6

3,5 x 9,5 Ø6 x 16 Ø6 Ø6 Ø6
 x 1a x 2b x 2d x 2e x 2f

Ø4 x 12 Ø4 Ø4 Ø4
 x 1c x 1g x 1h x 1 break nut / frein
 Fibre Fiber
 Fibre Fiber

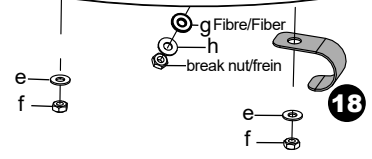
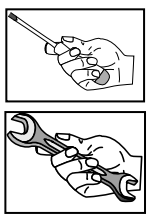
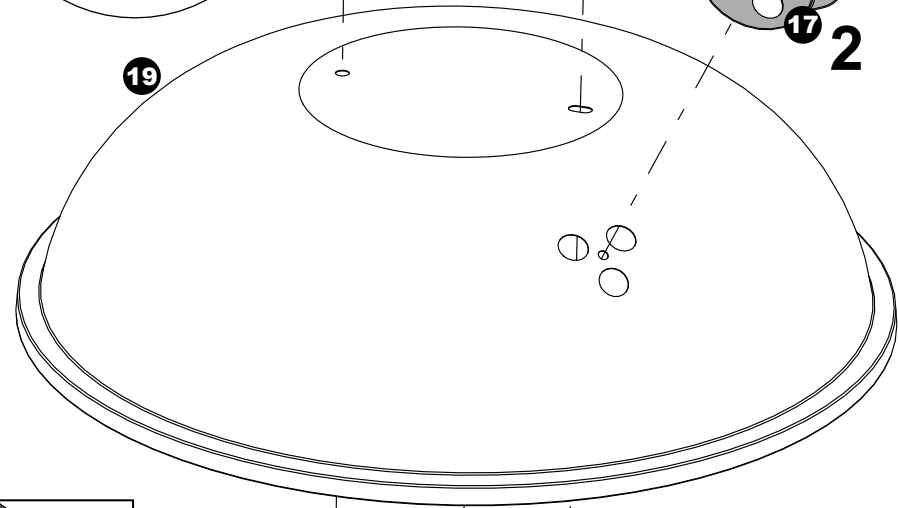
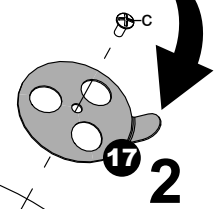
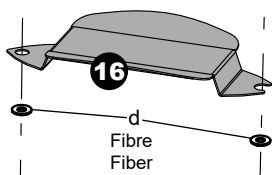
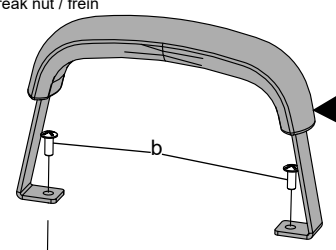
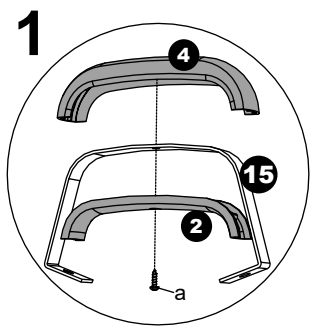

7

